

Its Thyme

PELLEOSSA

by Francesco Faccin

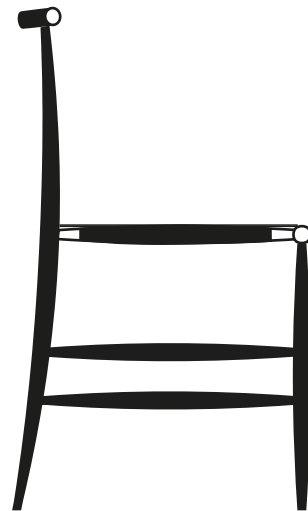

Pelleossa è una sedia eclettica, slanciata, che esprime il suo carattere nei dettagli. Si ispira alle sedie italiane di epoca preindustriale inserendo l'atteggiamento dell'arte concettuale. Disponibile anche con i braccioli, si completa con le diverse combinazioni della seduta.

Pelleossa is a slender, eclectic chair that expresses its character through detail. It is inspired by the Italian chairs of pre-industrial times, sporting the attitude of conceptual art. Also available with armrests, it completes with the different combinations of the seat.

Its Thyme

DIMENSIONI | DIMENSIONS

lunghezza | width: 39,2 cm
larghezza | depth: 49,9 cm
altezza | height: 84 cm
altezza del sedile | seat height: 47,4 cm

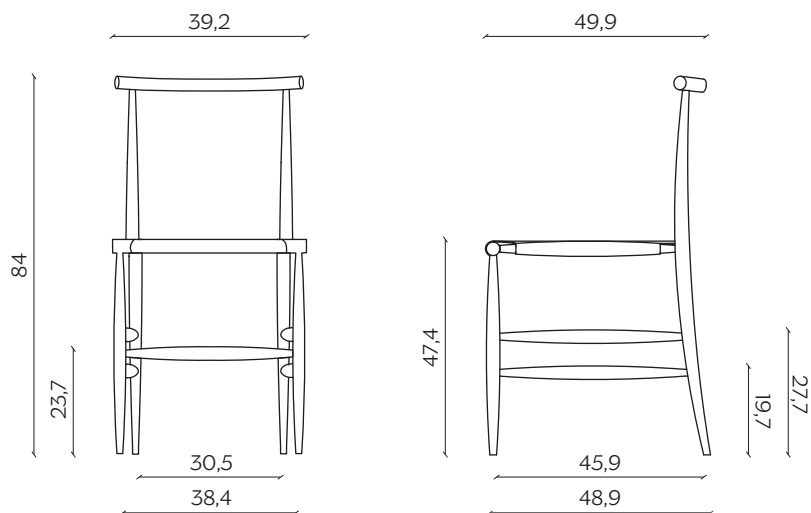

AMBIENTE | ENVIRONMENT

interno | indoor

Its Thyme

FINITURE | FINISHES

TESSUTI | FABRICS

Sponge



Crigio Chiaro
Light Grey

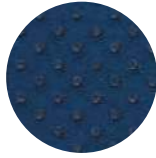

Blu
Blue

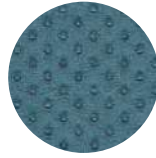

Azzurro
Light Blue

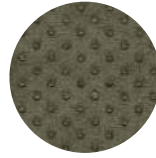

Verde
Green

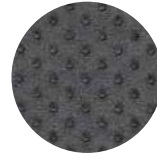

Crigio Scuro
Dark Gray



Arancio
Orange



Beige
Beige



Giallo
Yellow

Millennial Visual

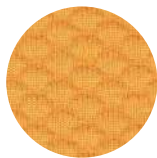

315



327

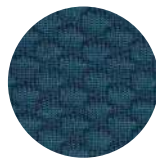

328

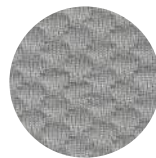

313

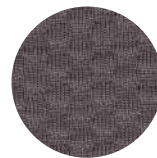

319

Cuoio | Leather



Bianco
White

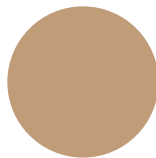

Naturale
Natural

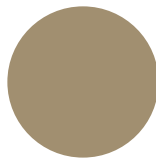

Tortora
Dove Grey

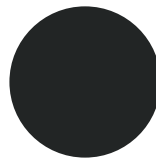

Nero
Black

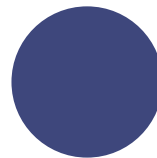

Blu
Blue

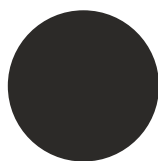

Testa di Moro
Dark Brown

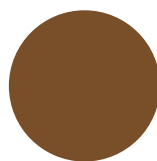

Vegetale
Vegetal

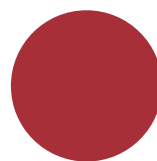

Rosso
Red

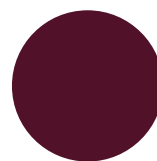

Vinaccia
Burgundy Red

Paglia di Fiume | Traditional Straw



Its Thyme

STRUTTURA | STRUCTURE

Legno | Wood



Rovere
Oak



Anilina Nera
Black Aniline



Noce Canaletto
Canaletto
Walnut

Its Thyme

PELLEOSSA WITH ARMREST

by Francesco Faccin

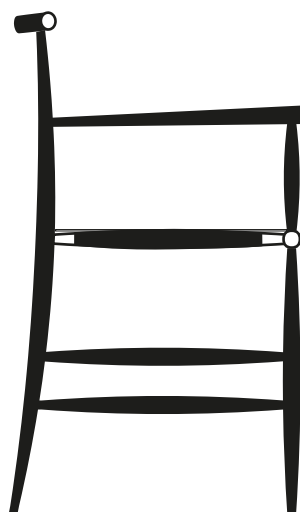

Pelleossa è una sedia eclettica, slanciata, che esprime il suo carattere nei dettagli. Si ispira alle sedie italiane di epoca preindustriale inserendo l'atteggiamento dell'arte concettuale. Disponibile anche con i braccioli, si completa con le diverse combinazioni della seduta.

Pelleossa is a slender, eclectic chair that expresses its character through detail. It is inspired by the Italian chairs of pre-industrial times, sporting the attitude of conceptual art. Also available with armrests, it completes with the different combinations of the seat.

Its Thyme

DIMENSIONI | DIMENSIONS

lunghezza | width: 50,1 cm

larghezza | depth: 52,5 cm

altezza | height: 86,1 cm

altezza del sedile | seat height: 47,2 cm

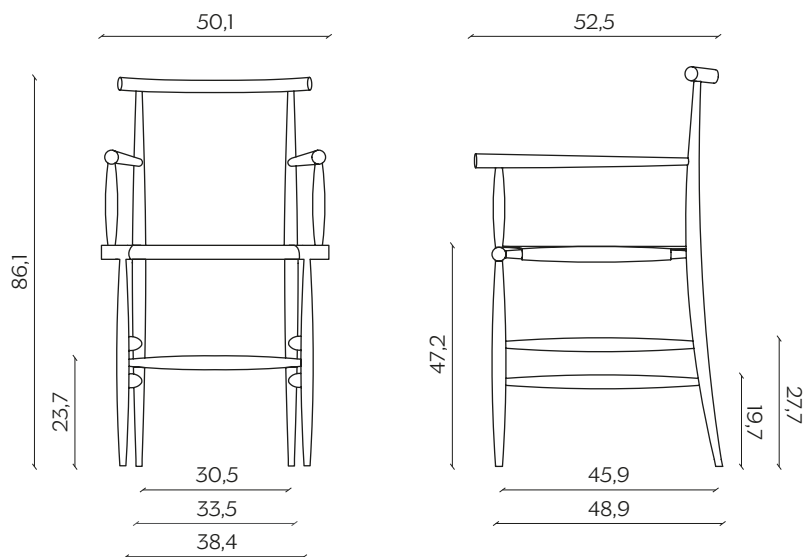

Its Thyme

FINITURE | FINISHES

TESSUTI | FABRICS

Sponge



Crigio Chiaro
Light Grey

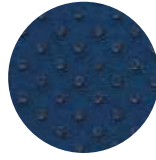

Blu
Blue

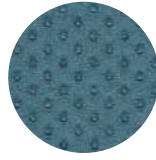

Azzurro
Light Blue

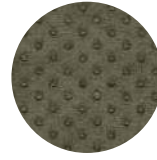

Verde
Green

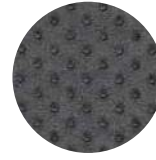

Crigio Scuro
Dark Gray



Arancio
Orange



Beige
Beige



Giallo
Yellow

Millennial Visual

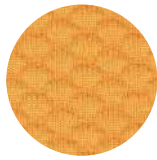

315



327

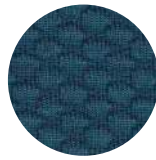

328

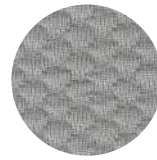

313

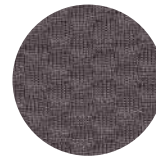

319

Cuoio | Leather



Bianco
White

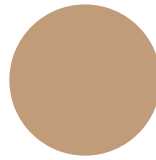

Naturale
Natural

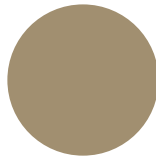

Tortora
Dove Grey

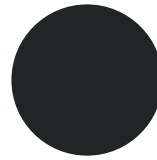

Nero
Black

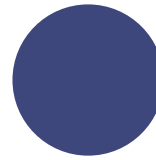

Blu
Blue

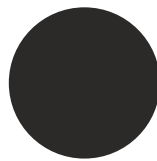

Testa di Moro
Dark Brown

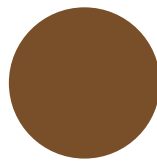

Vegetale
Vegetal

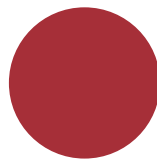

Rosso
Red

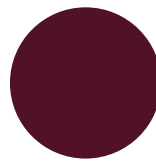

Vinaccia
Burgundy Red

Paglia di Fiume | Traditional Straw



Its Thyme

STRUTTURA | STRUCTURE

Legno | Wood



Rovere
Oak



Anilina Nera
Black Aniline



Noce Canaletto
Canaletto
Walnut